

Hendrick

ARCHITECTURAL

Fountain Covers & Trench Drains Technical Sheet

877-840-0881





www.hendrickarch.com

arch@hendrickcorp.com

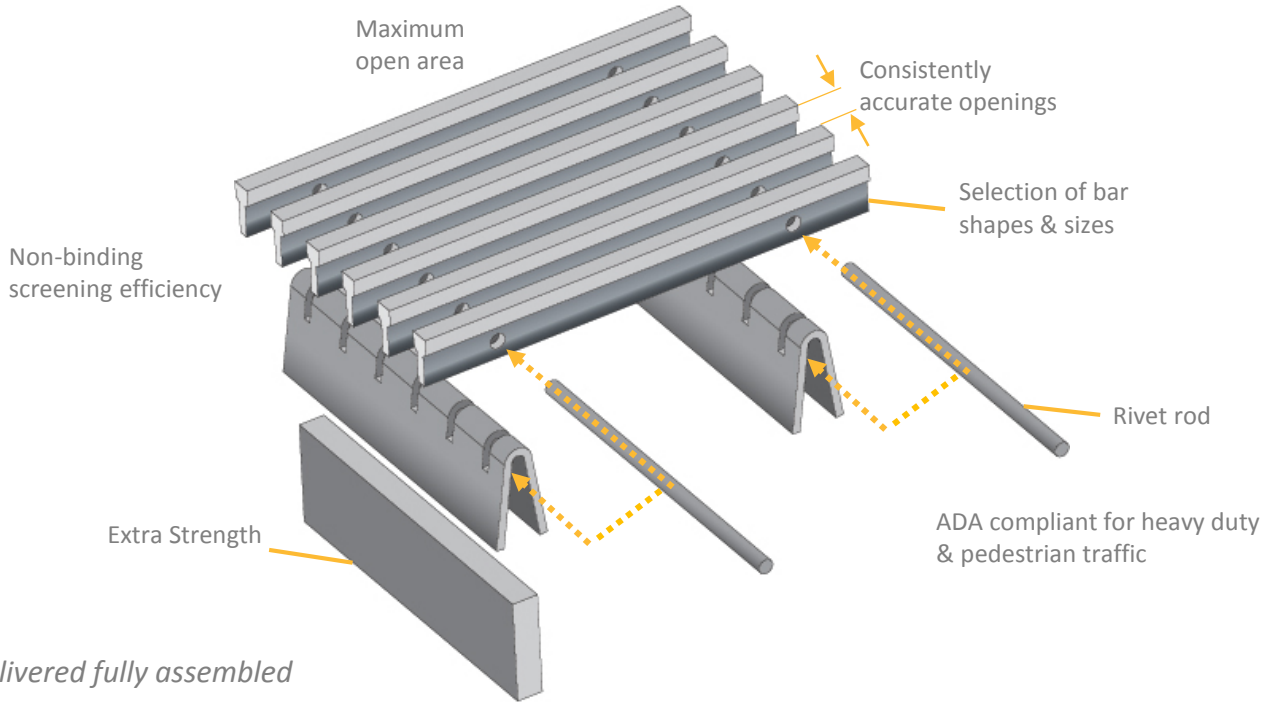
Carbondale, PA | Elgin, IL | Owensboro, KY

Hendrick's *Profile Bar** is manufactured using a mechanically interlocked proprietary method of construction, making it one of the strongest systems available on the market. It's perfect for applications that require high strength or a very flat surface.



Profile Bar Images not to scale				
	T16	B16	B12	B9
Bar Width	.250"	.250"	.187"	.140"
Assembly Depths	1-1/4"	11/16" 13/16" 1-1/8"	11/16" 13/16" 1-1/8"	5/8" 3/4" 1-1/8"
<u>Options</u>				
Anti-Slip Coating	✓	✓	✓	✓

 *Hendrick's proprietary high-strength, mechanically interlocked construction method.

Hendrick

ARCHITECTURAL

Fountain Covers & Trench Drains Load Chart

877-840-0881

www.hendrickarch.com

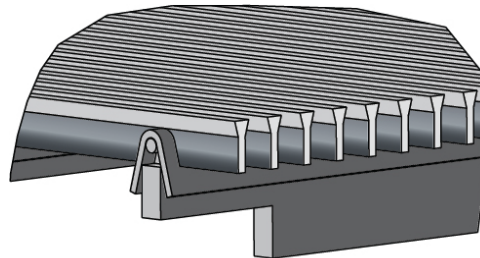
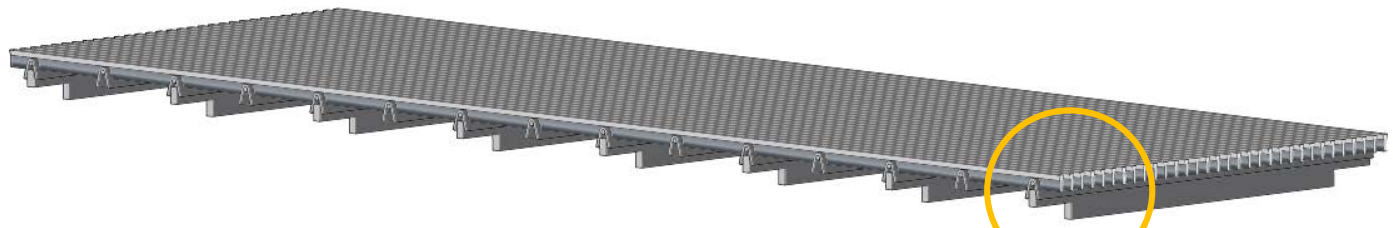
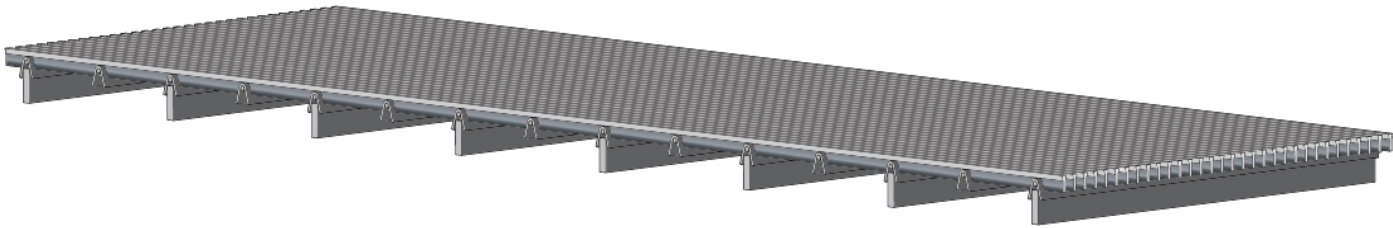

arch@hendrickcorp.com

Carbondale, PA | Elgin, IL | Owensboro, KY



Inserts – Optional Notched

Load Recommendation Guide

	<p>Pedestrian</p> <ul style="list-style-type: none"> ⌘ Loads of 1-300 PSF ⌘ Recommended for pedestrians, bicycles and wheel chair traffic
	<p>Auto</p> <ul style="list-style-type: none"> ⌘ Loads up to 2,200 lbs. ⌘ Recommended for medium-duty pneumatic tire traffic, autos and light trucks at speeds less than 20 mph
	<p>H-20</p> <ul style="list-style-type: none"> ⌘ Loads up to 20,800 lbs. ⌘ Recommended for heavy-duty pneumatic tire forklifts and tractor trailers at speeds less than 20 mph

Hendrick

ARCHITECTURAL

Fountain Covers & Trench Drains Load Chart





















877-840-0881

www.hendrickarch.com

arch@hendrickcorp.com

Carbondale, PA | Elgin, IL | Owensboro, KY

Chart based on minimum depth of 1-1/8" for open span listed below.

	BAR	Insert Size (in)	Insert Spacing (in)	Support Spacing (in)	BAR	Insert Size (in)	Insert Spacing (in)	Support Spacing (in)	BAR	Insert Size (in)	Insert Spacing (in)	Support Spacing (in)
6" Grate												
	B9	-	-	3	B12	-	-	3	T16	-	-	3
	B9	1/4 x 1	3	3	B12	1/4 x 1	3	3	T16	1/4 x 1	3	3
	B9	1/4 x 1-1/4	3	3	B12	1/4 x 1-1/4	3	3	T16	1/4 x 1-1/4	3	3
10" Grate												
	B9	1/4 x 1/2	6	3	B12	1/4 x 1/2	6	3	T16	1/4 x 1/2	6	3
	B9	1/4 x 1-1/2	6	3	B12	1/4 x 1-1/2	6	3	T16	1/4 x 1-1/2	6	3
	B9	1/4 x 1-1/2	3	3	B12	1/4 x 1-1/2	3	3	T16	1/4 x 2	3	3
14" Grate												
	B9	1/4 x 1	6	3	B12	1/4 x 1	6	3	T16	1/4 x 1	6	3
	B9	1/4 x 1-1/2	3	3	B12	1/4 x 1-1/2	3	3	T16	1/4 x 2	6	3
	B9	1/4 x 2-1/2	3	3	B12	1/4 x 2-1/2	3	3	T16	1/4 x 2-1/2	3	3
20" Grate												
	B9	1/4 x 1	6	3	B12	1/4 x 1	3	3	T16	1/4 x 1	3	3
	B9	1/4 x 2	3	3	B12	1/4 x 2	3	3	T16	1/4 x 2	3	3
	B9	1/4 x 3-1/2	3	3	B12	1/4 x 3-1/2	3	3	T16	1/4 x 3-1/2	3	3
26" Grate												
	B9	1/4 x 1-1/2	3	3	B12	1/4 x 1-1/2	3	3	T16	1/4 x 1-1/2	3	3
	B9	1/4 x 2-1/2	3	3	B12	1/4 x 2-1/2	3	3	T16	1/4 x 2-1/2	3	3
	B9	1/4 x 4	3	3	B12	1/4 x 4	3	3	T16	1/4 x 4	3	3
36" Grate												
	B9	1/4 x 2	6	3	B12	1/4 x 2	6	3	T16	1/4 x 2	6	3
	B9	1/4 x 3	3	3	B12	1/4 x 3	3	3	T16	1/4 x 3	3	3
	B9	1/4 x 5-1/2	3	3	B12	1/4 x 5-1/2	3	3	T16	1/4 x 5-1/2	3	3
48" Grate												
	B9	1/4 x 2-1/2	6	3	B12	1/4 x 2-1/2	6	3	T16	1/4 x 2-1/2	6	3
	B9	1/4 x 3-1/2	3	3	B12	1/4 x 3-1/2	3	3	T16	1/4 x 3-1/2	3	3
	B9	1/4 x 6-1/2	3	3	B12	1/4 x 6-1/2	3	3	T16	1/4 x 6-1/2	3	3